

Insert sizes into boxes A & B

**Shutter secure
from this side**

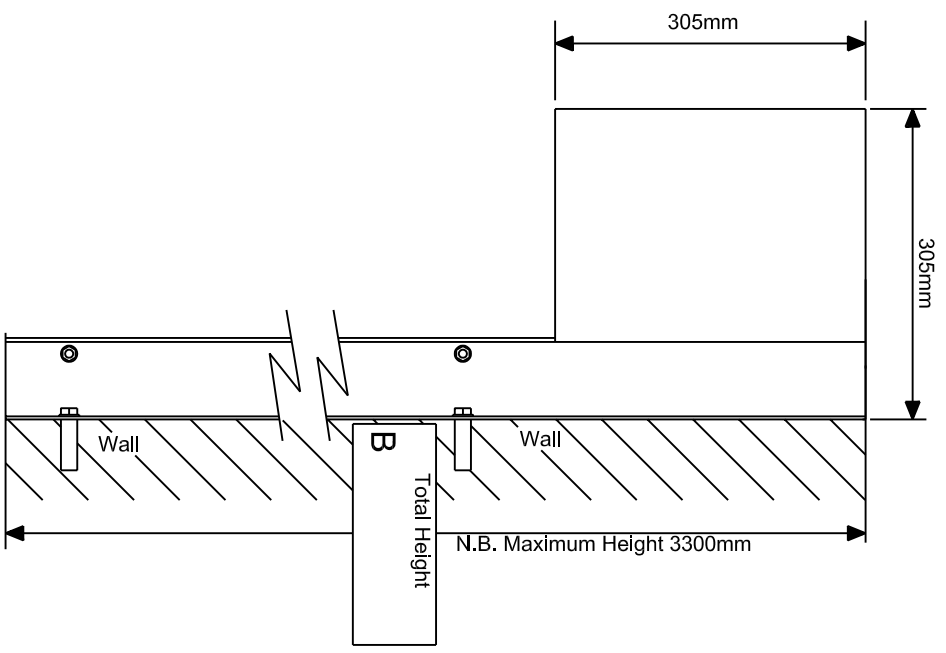
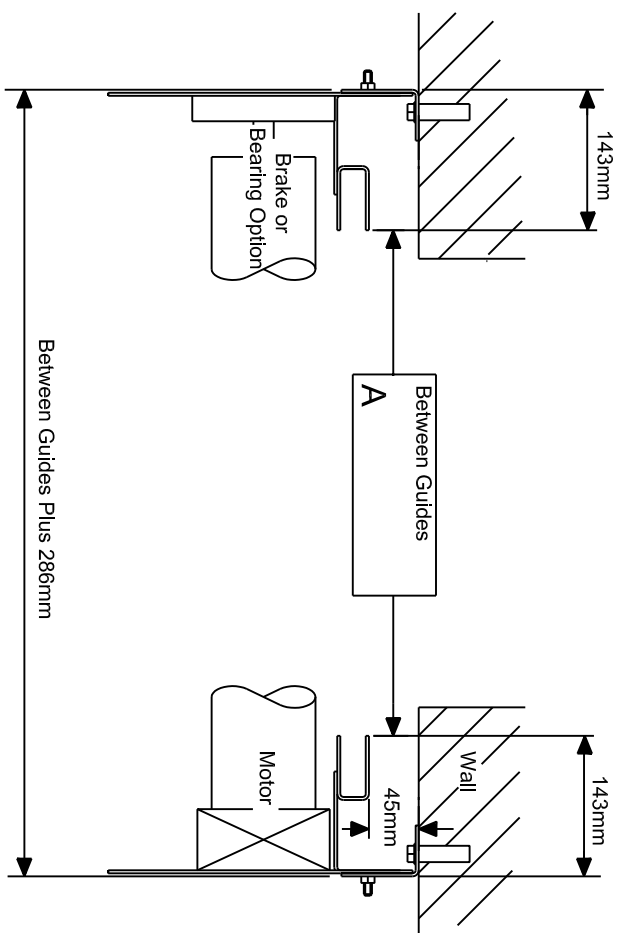

Kenrick Door Systems

Booth St. Smethwick
West Midlands. B66 2PF
Tel: 0121 565 0022
Fax: 0121 565 0055
Email:
sales@kenrickdoorsystems.co.uk

Title:

**Right Hand Tube
Motor Shutter
Face Fixed
Drg No 03007**

Client Approval/Order Box

Company

Signature

Print Name

Date

Order No.

Modification record

Date

No.

Not to scale

Drawn By

Approved X

Date

Issue No. 1

Drg No. 03007